

Ogi Y

technical specification



.mdd

.mdd has a leading position among manufacturers of office furniture with many awards that prove quality and continuously increase demand for it's products.

The realities of today`s market require constant quality improvement at all levels of modern organization. This applies in particular to customer service, marketing, quality of products and also to quality of processes within the company. Partnership relations among employees and with business partners form a base of economic growth and success of the company.

Constant investments in innovative machinery park, optimization of management systems and an expansion of production halls allow to minimize the lead times for the product of the highest quality.

More than twenty years of experience in office furniture industry come with reference from a long list of companies and institutions to show their appreciation for an efficient and comprehensive service.

.mdd is higly aware of the environment.

Being located in the forest region with lake by itis side, .mdd takes the nature seriously and invests constantly in a modern and energy-efficient solutions to preserve the local life. Company puts emphasis on waste segregation and recycling. .mdd has been awarded for the exceptional care and involvement in waste disposal. All materials used are environmentally friendly and enjoy a high 95 % rate of being recycled.



General informations:

Warranty:

.mdd products – **5 years**.
Electrical components and fabric – **2 years**.

Certyficate - MFC:



Compliant with standards:

PN-EN 527-2:2017-02

Boards density:

- 12 mm - 690 - 750 kg/m³
- 18 mm - 650 - 690 kg/m³
- 28 mm - 610 - 630 kg/m³
- 36 mm - 610 - 630 kg/m³

Assembly:

product delivered in separate elements

Packing:

cardboard

Ogi Y	Date of preparation 15.01.2021	The data contained in this document is valid in the day of its preparation. Change of the product, as long as it does not affect the basic features of it, does not require consistent updates of the document.	page 2/10 general informations
-------	-----------------------------------	---	--

Ogi desk worktops

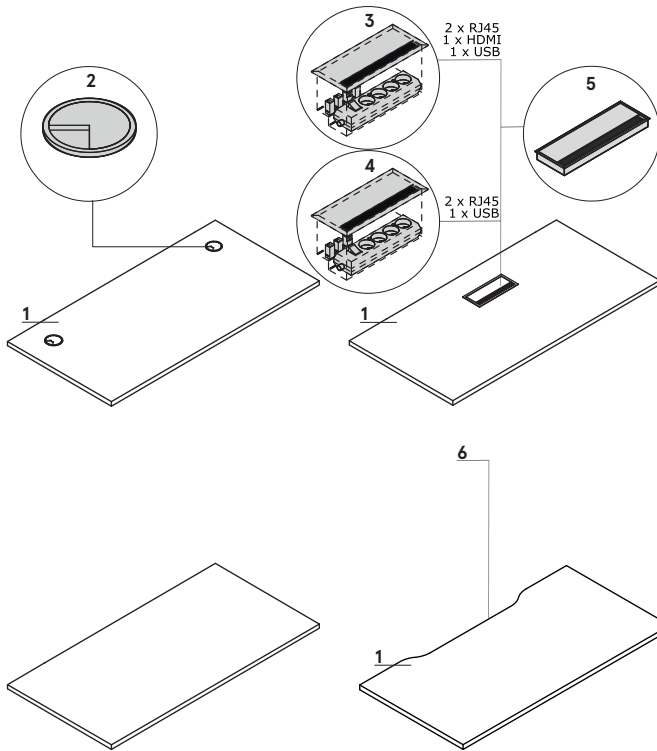

1. Worktop - MFC 28 mm, ABS edge

OPTIONS WITH EXTRA CHARGE:

2. Grommet - 2 pcs, Ø 80 mm

3. Mediabox M04H - 2xRJ45 (class E, cat. 6); +1 x USB + 1 x HDMI + 4x 230V, colour: M009 - aluminium semi-matt

4. Mediabox M04 - 2xRJ45 (class E, cat. 6); +1 x USB + 4x 230V, colour: M009 - aluminium semi-matt

5. Top access M05 - colour: M009 - aluminium semi-matt

6. Cable way - in bench type desks, the width of the opening is proportional to the width of the worktop

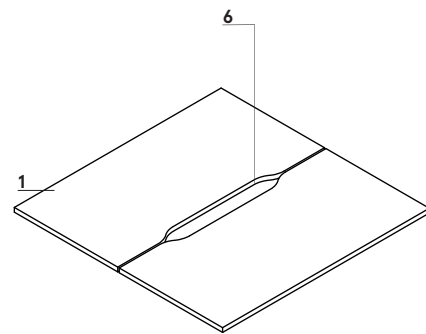

Dimensions of radial worktops (mm)

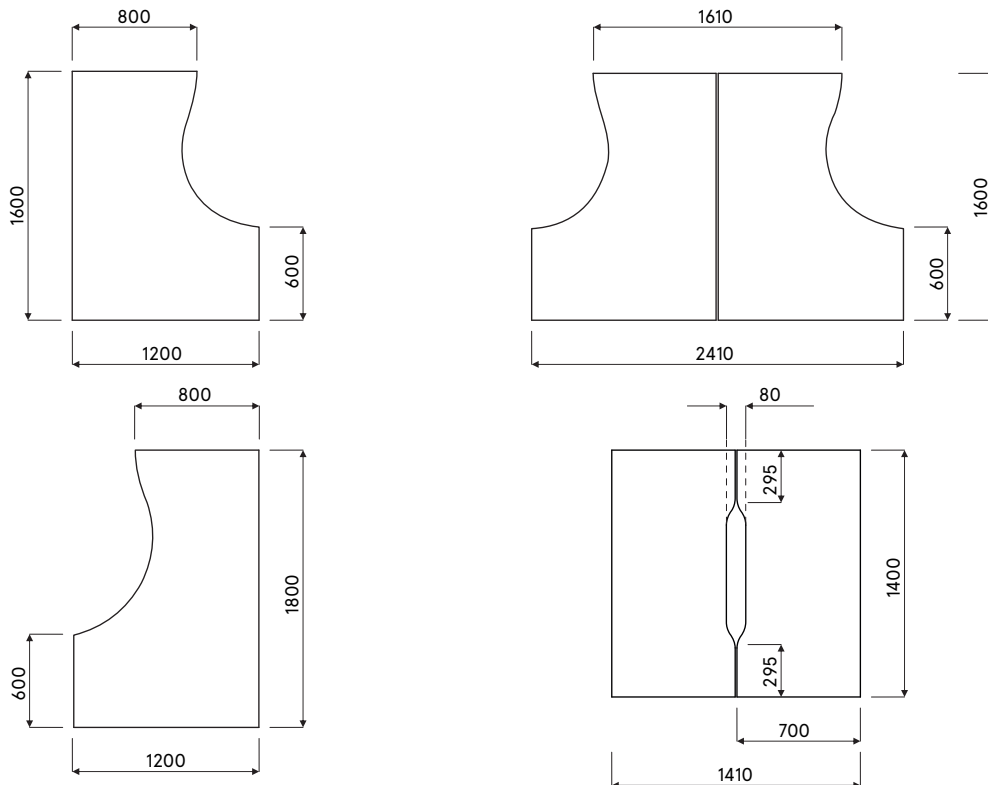

Frame

Ogi Y: powder coated steel, profile 40x40 mm, spacer 10 mm between top and frame

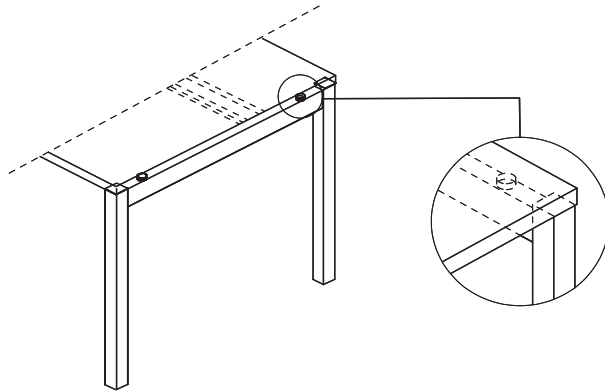

Attention - the cable tray located underneath the worktop is only available in: M009 - aluminium semi-matte colour

Desk with managerial storage

- 1. Worktop - MFC 28 mm, ABS edge
- 2. Top - MFC 28 mm, ABS edge
- 3. Shelf - MFC 18 mm, protection against accidental falling-out, ABS edge
- 4. Drawer - MFC 18 mm, ABS edge, patent lock - possible to change location
- 5. Base - MFC 18 mm, ABS edge
- 6. Front - MFC 18 mm, ABS edge

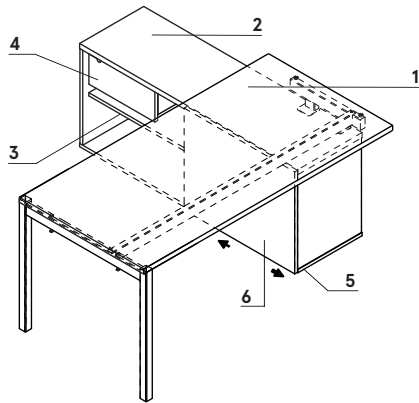

www.mdd.eu

Configuration examples (mm)

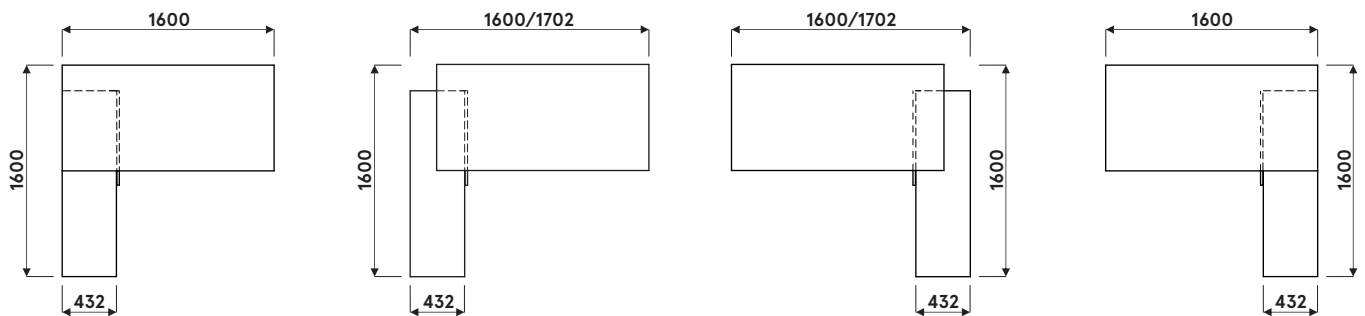

Configuration examples (mm)

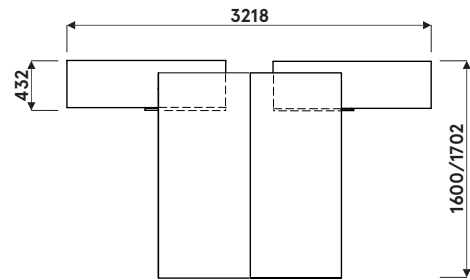
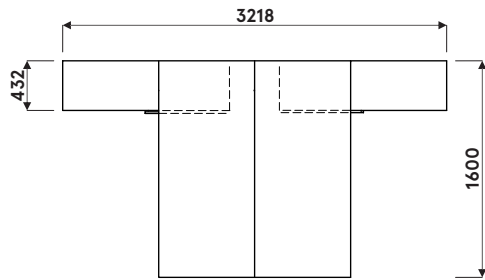

Configuration examples with BOX40, BOX50, BOX60

www.mdd.eu

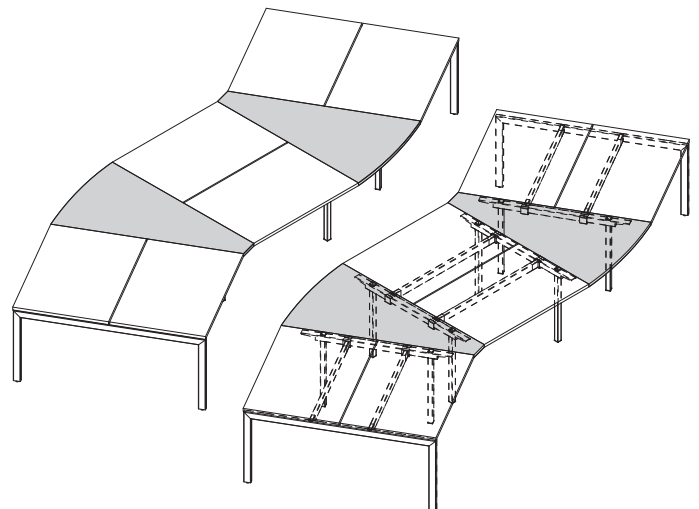
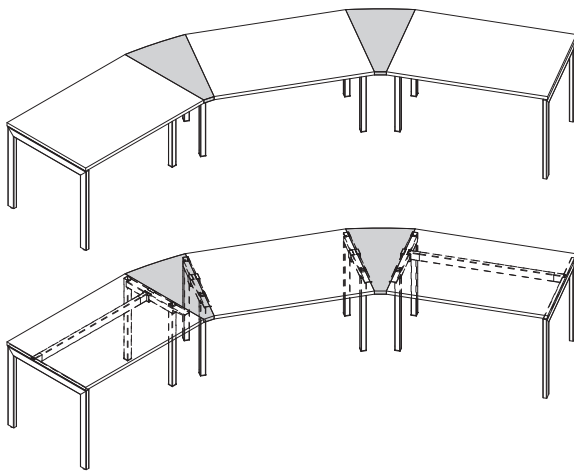

ATTENTION - only for Ogi Q, Ogi U, Ogi Y, Ogi M

Accessories

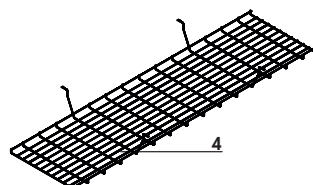
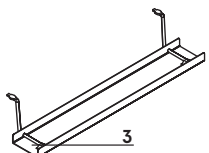
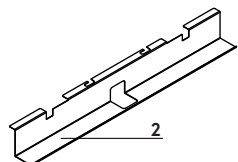
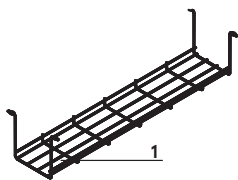

1. Horizontal cable tray S69 - powder coated, colour: 09 - aluminum
2. Single desk horizontal cable tray (SG12, SG16) - powder coated metal, colour: M009 - aluminum semi-matt
3. Horizontal cable tray E64 - powder coated, colour: M009 - aluminium semi-matt
4. Cable tray for bench desks (SG220, SG260) - steel wire Ø4 mm, powder coated, colour: 09 - aluminum

Ogi Y	Date of preparation 15.01.2021	The data contained in this document is valid in the day of its preparation. Change of the product, as long as it does not affect the basic features of it, does not require consistent updates of the document.	page 5/10 technical description
-------	-----------------------------------	---	------------------------------------

Desks



BOY12
1200 / 600 / 740
30.3 kg

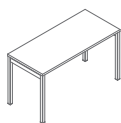

BOY14
1400 / 600 / 740
33.4 kg

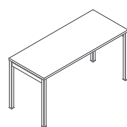

BOY16
1600 / 600 / 740
36.5 kg



BOY22
1200 / 700 / 740
31.7 kg



BOY24
1400 / 700 / 740
35.1 kg

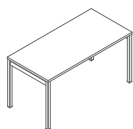

BOY26
1600 / 700 / 740
38.7 kg



BOY02
1200 / 800 / 740
37.3 kg

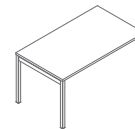

BOY03
1400 / 800 / 740
37.8 kg

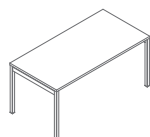

BOY04
1600 / 800 / 740
38.4 kg

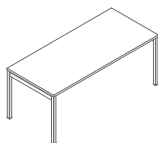

BOY05
1800 / 800 / 740
41.5 kg

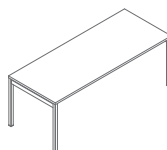

BOY06
2000 / 800 / 740
49.2 kg

www.mdd.eu

Elements for arrangement building - straight desk



BOX40
500 / 800 / 740
10.8 kg

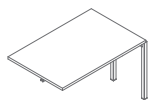

BOX42
1200 / 800 / 740
31.6 kg

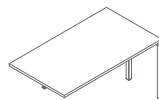

BOX43
1400 / 800 / 740
32.1 kg

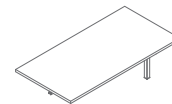

BOX44
1600 / 800 / 740
32.7 kg

Elements for arrangement building - straight desk

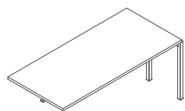

BOX45
1600 / 800 / 740
35.8 kg

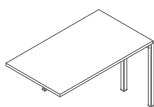

BOX32
1200 / 700 / 740
26.3 kg

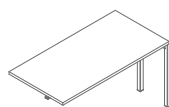

BOX34
1400 / 700 / 740
29.7 kg

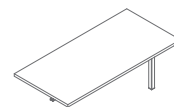

BOX36
1600 / 700 / 740
33.3 kg

Bench desks

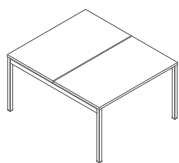

BOY42
1200 / 1410 / 740
57.2 kg

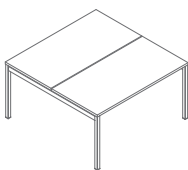

BOY44
1400 / 1410 / 740
64 kg

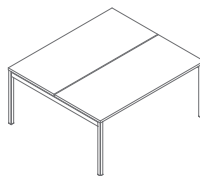

BOY46
1600 / 1410 / 740
71.2 kg

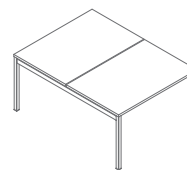

BOY32
1200 / 1610 / 740
68.3 kg

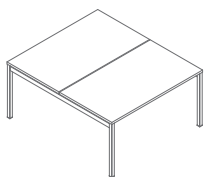

BOY33
1400 / 1610 / 740
69.3 kg

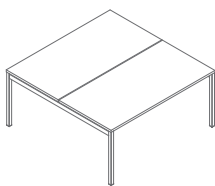

BOY34
1600 / 1610 / 740
70.5 kg

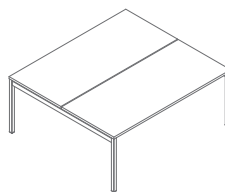

BOY35
1800 / 1610 / 740
76.7 kg

www.mdd.eu

Elements for arrangement building - bench

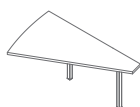

BOX50
1000 / 1410 / 740
16.5 kg

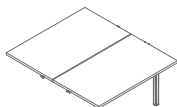

BOX52
1200 / 1410 / 740
49.4 kg

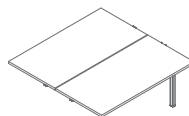

BOX54
1400 / 1410 / 740
56.2 kg

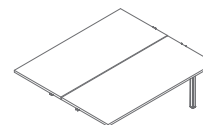

BOX56
1600 / 1410 / 740
63.4 kg

Elements for arrangement building - bench

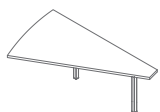

BOX60
1000 / 1610 / 740
17,5 kg

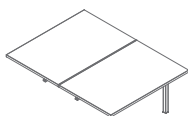

BOX62
1200 / 1610 / 740
60.1 kg

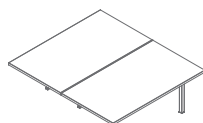

BOX64
1400 / 1610 / 740
61.1 kg

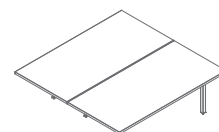

BOX66
1600 / 1610 / 740
62.3 kg

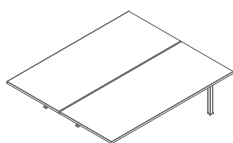

BOX68
1800 / 1610 / 740
68,5 kg

Desks with managerial storage

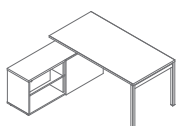

BOYL20
1600-1702 / 1600 / 740
94.1 kg

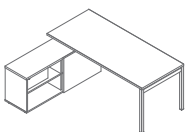

BOYL21
1800-1902 / 1600 / 740
95.6 kg

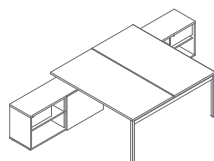

BOYL40
1600-1702 / 3210 / 740
181.9 kg

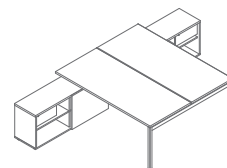

BOYL41
1800-1902 / 3210 / 740
188.1 kg

Desk extensions

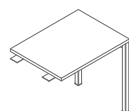

PLY01
600 / 800 / 740
18.7 kg

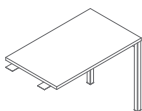

PLY02
600 / 1000 / 740
19.9 kg

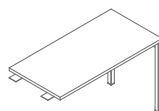

PLY03
600 / 1200 / 740
22.4 kg

Radial desks



BOY10
1600 / 1200 / 740
45.6 kg

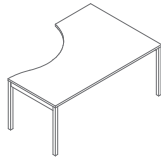

BOY17
1800 / 1200 / 740
41.5 kg

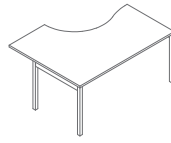

BOY11
1600 / 1200 / 740
45.6 kg

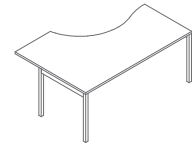

BOY18
1800 / 1200 / 740
43.5 kg

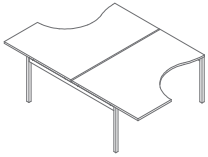

BOY15
1600 / 2410 / 740
84.9 kg

Worktop, top, base, body, front

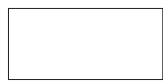
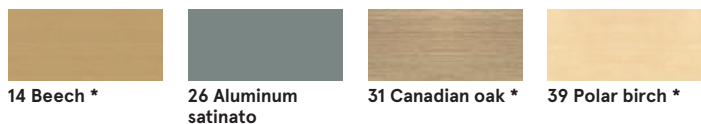

67 White pastel

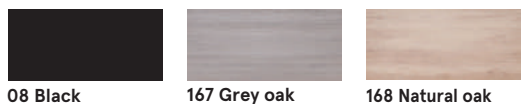

34 Chestnut *

64 Cocoa *

106 Lowland walnut *

154 Anthracite

08 Black

167 Grey oak

168 Natural oak

Grommet



Aluminum



White



Black

Frame, mediabox - metal



M009 Aluminum semi-matt RAL9006

M015 White semi-matt RAL9010

M154 Antracite semi-matt RAL7043

M115 Black semi-matt RAL9005

* body - II group