

Storages and bookcase - Standard technical specification



.mdd

MDD has a leading position among manufacturers of office furniture with many awards that prove quality and continuously increase demand for its products.

The realities of today's market require constant quality improvement at all levels of modern organization. This applies in particular to customer service, marketing, quality of products and also to quality of processes within the company.

Partnership relations among employees and with business partners form a base of economic growth and success of the company.

Constant investments in innovative machinery park, optimization of management systems and an expansion of production halls allow to minimize the lead times for the product of the highest quality.

More than twenty years of experience in office furniture industry come with reference from a long list of companies and institutions to show their appreciation for an efficient and comprehensive service.

MDD is highly aware of the environment.

Being located in the forest region with lake by its side, MDD takes the nature seriously and invests constantly in a modern and energy-efficient solutions to preserve the local life. Company puts emphasis on waste segregation and recycling. MDD has been awarded for the exceptional care and involvement in waste disposal. All materials used are environmentally friendly and enjoy a high 95 % rate of being recycled.



General informations:

Warranty:

MDD products – **5 years.**

Electrical components and fabric – **2 years.**

Certificate - MFC:



Compliant with standards:

PN-EN 14073-2:2006

Boards density:

12 mm - 690 - 750 kg/m³

18 mm - 650 - 690 kg/m³

28 mm - 610 - 630 kg/m³

36 mm - 610 - 630 kg/m³

Assembly:

product delivered in separate elements

Packing:

cardboard, bubble wrap, stretch foil

Storages and bookcase

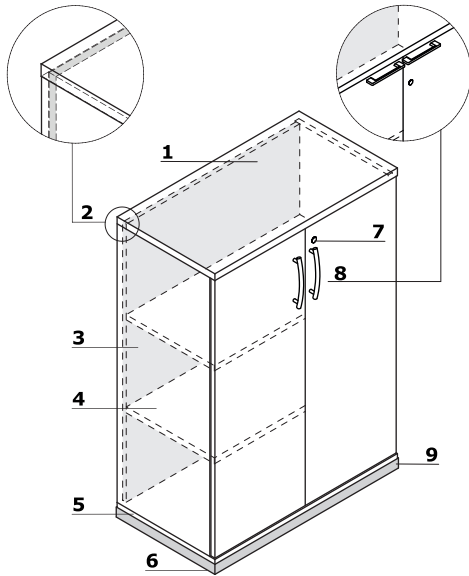

1. Top - MFC 28 mm, ABS edge
2. Back MFC - 18 mm, ABS edges
3. Body - MFC 18 mm, ABS edge
4. Shelf - MFC 18 mm, protection against accidental falling-out, ABS edge
5. Base - MFC 18 mm, ABS edge
6. Leveling feet 27 mm - range 12 mm
7. **OPTION WITH EXTRA CHARGE** - espagnolette lock - two-point
8. Front - MFC 18 mm, ABS edge, plain hinge 110°
 - Standard - vertical handle, aluminum
 - Pro (OPTION WITH EXTRA CHARGE) - horizontal handle, aluminium, espagnolette lock - two-point
9. **OPTION WITH EXTRA CHARGE** - metal base - colour: M009 - aluminium semi-matt

Storages *

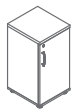

A26P2**
402 / 432 / 777
22 kg

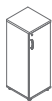

A36P2**
402 / 432 / 1129
30 kg



A56P2**
402 / 432 / 1833
46 kg



A21B4
801 / 432 / 740
35.5 kg

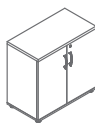

A2104
801 / 432 / 777
37 kg

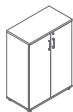

A3104
801 / 432 / 1129
46.3 kg

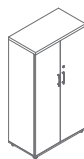

A4104
801 / 432 / 1481
62 kg

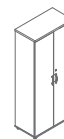

A5104
801 / 432 / 1833
78.6 kg



A6104
801 / 432 / 2185
90 kg



A5NP4**
802 / 802 / 1833
107 kg

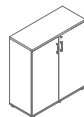

A3105
1000 / 432 / 1129
64 kg

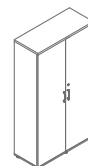

A5105
1000 / 432 / 1833
98 kg

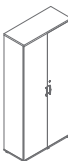

A6105
1000 / 432 / 2185
141 kg

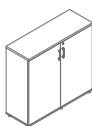

A3106
1200 / 432 / 1129
73 kg

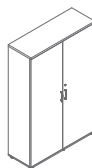

A5106
1200 / 432 / 1833
111 kg

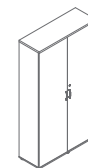

A6106
1200 / 432 / 2185
131 kg

* dimensions expressed in millimeters: width x depth x height
** option - left hand side or right hand side front

Bookcases *



A2902
402 / 432 / 777
19 kg



A3902
402 / 432 / 1129
25 kg



A5902
402 / 432 / 1833
39 kg



A25B4
801 / 432 / 740
29 kg



A2504
801 / 432 / 777
30 kg

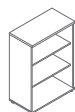

A3504
801 / 432 / 1129
35 kg

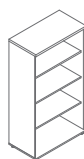

A4504
801 / 432 / 1481
49 kg



A5504
801 / 432 / 1833
60 kg

www.mdd.eu



A6504
801 / 432 / 2185
69 kg



A3505
1000 / 432 / 1129
51 kg



A5505
1000 / 432 / 1833
77 kg

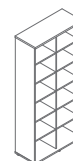

A6505
1000 / 432 / 2185
89 kg

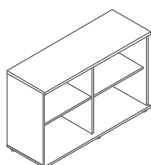

A2506
1200 / 432 / 777
46 kg



A3506
1200 / 432 / 1129
57 kg

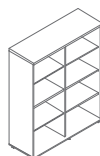

A4506
1200 / 432 / 1481
62 kg

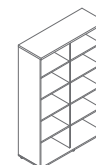

A5506
1200 / 432 / 1833
86 kg

* dimensions expressed in millimeters: width x depth x height

Bookcases *

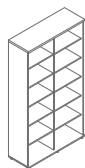

A6506
1200 / 432 / 2185
101 kg

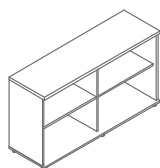

A2508
1600 / 432 / 777
55 kg

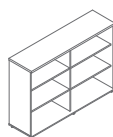

A3508
1600 / 432 / 1129
73 kg

Half bookcases *



A38P2**
402 / 432 / 1129
29 kg



A58P2**
402 / 432 / 1833
41 kg



A3404
801 / 432 / 1129
42 kg



A4304
801 / 432 / 1481
60.3 kg

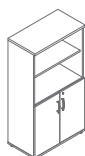

A4404
801 / 432 / 1481
56 kg

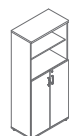

A5304
801 / 432 / 1833
71.3 kg

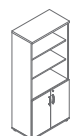

A5404
801 / 432 / 1833
67 kg

Desk cabinet *

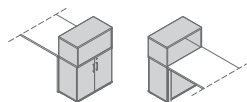

A3404B
801 / 432 / 1129
48 kg

* dimensions expressed in millimeters: width x depth x height
** option - left hand side or right hand side front

Stack-on storages 2OH *

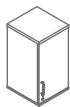

A16P2**
402 / 432 / 750
21 kg

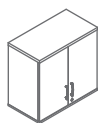

A1104
801 / 432 / 750
30 kg

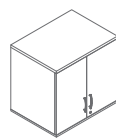

A1204
801 / 600 / 750
43,5 kg



A1NP4**
802 / 802 / 750
50 kg



A1902
402 / 432 / 750
18 kg



A1504
801 / 432 / 750
23 kg

Printer storage *



S85
710 / 600 / 600
32 kg

* dimensions expressed in millimeters: width x depth x height
** option - left hand side or right hand side front

Top, base, body, front

			
14 Beech *	26 Aluminum satinato	31 Canadian oak *	34 Chestnut *
			
39 Polar birch *	64 Cocoa *	67 White pastel	106 Lowland walnut *
			
154 Anthracite	08 Black	167 Grey oak *	168 Natural oak *

* body - II group