

# Meeting tables Ogi Y technical specification



.mdd

**.mdd has a leading position among manufacturers of office furniture with many awards that prove quality and continuously increase demand for it's products.**

The realities of today`s market require constant quality improvement at all levels of modern organization. This applies in particular to customer service, marketing, quality of products and also to quality of processes within the company.

Partnership relations among employees and with business partners form a base of economic growth and success of the company.

Constant investments in innovative machinery park, optimization of management systems and an expansion of production halls allow to minimize the lead times for the product of the highest quality.

**More than twenty years of experience in office furniture industry come with reference from a long list of companies and institutions to show their appreciation for an efficient and comprehensive service. .mdd is highly aware of the environment.**

Being located in the forest region with lake by it's side, .mdd takes the nature seriously and invests constantly in a modern and energy-efficient solutions to preserve the local life. Company puts emphasis on waste segregation and recycling. .mdd has been awarded for the exceptional care and involvement in waste disposal. All materials used are environmentally friendly and enjoy a high 95 % rate of being recycled.



**General informations:**

**Warranty:**

.mdd products - **5 years**.  
Electrical components and fabric - **2 years**.

**Certificate - MFC:**



**Compliant with standards:**

PN-EN 15372:2010

**Boards density:**

- 12 mm - 690 - 750 kg/m<sup>3</sup>
- 18 mm - 650 - 690 kg/m<sup>3</sup>
- 28 mm - 610 - 630 kg/m<sup>3</sup>
- 36 mm - 610 - 630 kg/m<sup>3</sup>

**Assembly:**

product delivered in separate elements

**Packing:**

cartboard

## Worktop

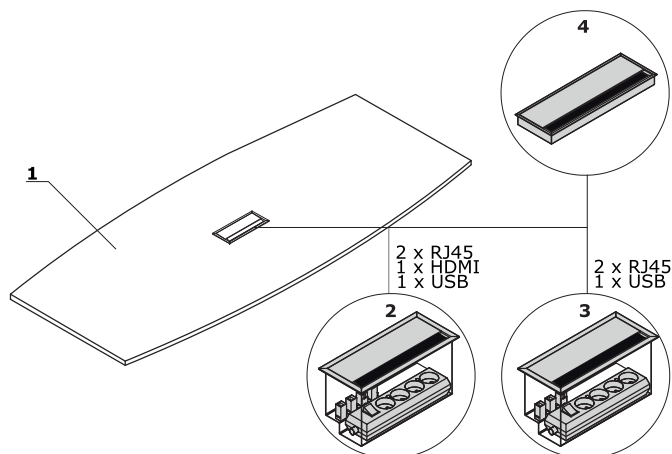

1. **Worktop** - MFC 28 mm, ABS edge
- OPTIONS WITH EXTRA CHARGE:**
2. **Mediabox M04H** - 2xRJ45 (class E, cat. 6); +1 x USB + 1 x HDMI + 4x 230V, colour: M009 - aluminium semi-matt
3. **Mediabox M04** - 2xRJ45 (class E, cat. 6); +1 x USB + 4x 230V, colour: M009 - aluminium semi-matt
4. **Top access M05** - colour: M009 - aluminium semi-matt

## Frame - meeting tables Ogi Y

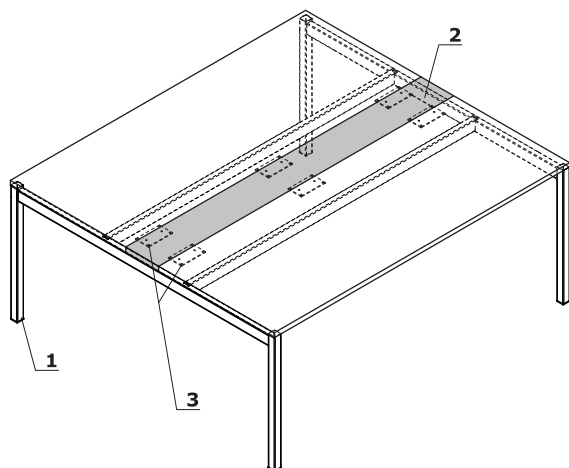

1. **Leg** - powder coated steel, profile 40x40 mm
2. **MFC element** - colour: 26 - aluminum satinato, 67 - white pastel, 154 - anthracite, 08 - black; without mediabox as standard
3. **Fixing flat bar**

ATTENTION: MFC element matches with frame colour

Meeting tables Ogi Y \*

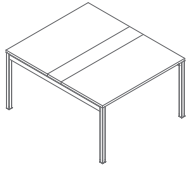

**SY22**  
1200 / 1410 / 740  
56.6 kg

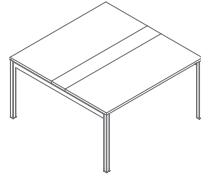

**SY24**  
1400 / 1410 / 740  
60.4 kg

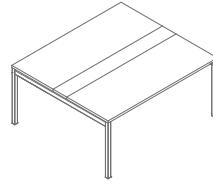

**SY26**  
1600 / 1410 / 740  
66.6 kg

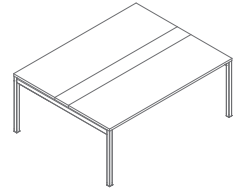

**SY28**  
1800 / 1410 / 740  
75.2 kg

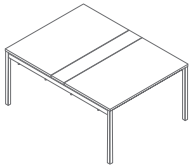

**SY02**  
1200 / 1610 / 740  
63.9 kg

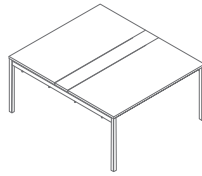

**SY04**  
1400 / 1610 / 740  
71.7 kg

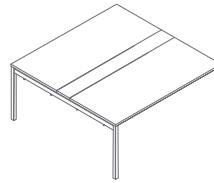

**SY06**  
1600 / 1610 / 740  
79.9 kg

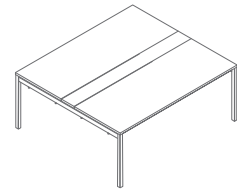

**SY08**  
1800 / 1610 / 740  
88.5 kg

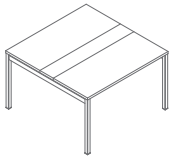

**SY42**  
1200 / 1210 / 740  
46.7 kg

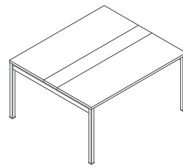

**SY44**  
1400 / 1210 / 740  
51.7 kg

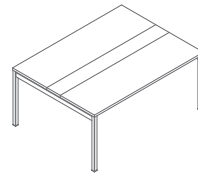

**SY46**  
1600 / 1210 / 740  
57.9 kg

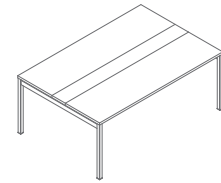

**SY48**  
1800 / 1210 / 740  
64.7 kg

\* dimensions expressed in millimeters: width x depth x height

Elements for pairing Ogi Y \*

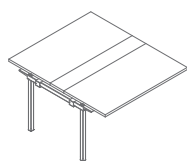

**SY32**  
1200 / 1410 / 740  
48.8 kg

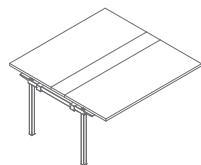

**SY34**  
1400 / 1410 / 740  
52.6 kg

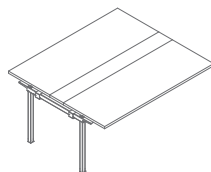

**SY36**  
1600 / 1410 / 740  
58.8 kg

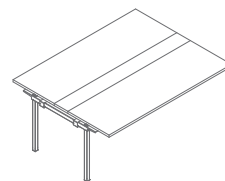

**SY38**  
1800 / 1410 / 740  
67.4 kg

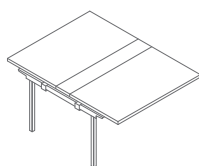

**SY12**  
1200 / 1610 / 740  
55.7 kg

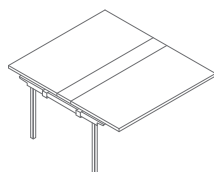

**SY14**  
1400 / 1610 / 740  
63.5 kg

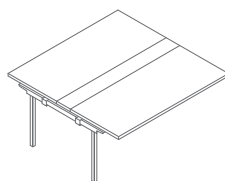

**SY16**  
1600 / 1610 / 740  
71.7 kg

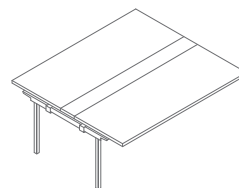

**SY18**  
1800 / 1610 / 740  
80.3 kg

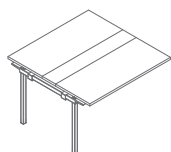

**SY52**  
1200 / 1210 / 740  
40 kg

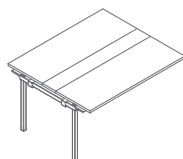

**SY54**  
1400 / 1210 / 740  
45 kg

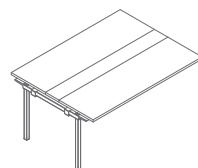

**SY56**  
1600 / 1210 / 740  
51.2 kg

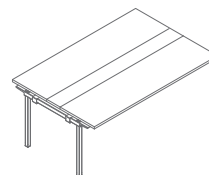

**SY58**  
1800 / 1210 / 740  
58 kg

Elements for pairing Ogi Y \*

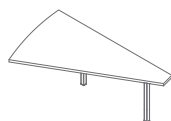

**BOX60**  
1000 / 1610 / 740  
17.5 kg

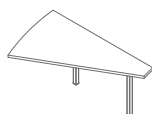

**BOX50**  
1000 / 1410 / 740  
16.5 kg

\* dimensions expressed in millimeters: width x depth x height

Top



14 Beech



26 Aluminum satinato



31 Canadian oak

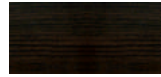

34 Chestnut



39 Polar birch



64 Cocoa

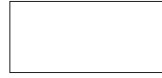

67 White pastel



106 Lowland walnut



154 Anthracite



08 Black



167 Grey oak



168 Natural oak

Frame



M009 Aluminum semi-mat RAL9006



M015 White semi-mat RAL9010



M154 Anthracite semi-mat RAL7043



M115 Black semi-mat RAL9005