

Glass door storages - Standard technical specification



.mdd

MDD has a leading position among manufacturers of office furniture with many awards that prove quality and continuously increase demand for its products.

The realities of today's market require constant quality improvement at all levels of modern organization. This applies in particular to customer service, marketing, quality of products and also to quality of processes within the company.

Partnership relations among employees and with business partners form a base of economic growth and success of the company.

Constant investments in innovative machinery park, optimization of management systems and an expansion of production halls allow to minimize the lead times for the product of the highest quality.

More than twenty years of experience in office furniture industry come with reference from a long list of companies and institutions to show their appreciation for an efficient and comprehensive service.

MDD is highly aware of the environment.

Being located in the forest region with lake by its side, MDD takes the nature seriously and invests constantly in a modern and energy-efficient solutions to preserve the local life. Company puts emphasis on waste segregation and recycling. MDD has been awarded for the exceptional care and involvement in waste disposal. All materials used are environmentally friendly and enjoy a high 95 % rate of being recycled.



General informations:

Warranty:

MDD products – **5 years.**

Electrical components and fabric – **2 years.**

Certificate - MFC:



Assembly:

product delivered in separate elements

Packing:

cardboard, bubble wrap, stretch foil

Compliant with standards:

PN-EN 14073-2:2006

Boards density:

12 mm - 690 - 750 kg/m³

18 mm - 650 - 690 kg/m³

28 mm - 610 - 630 kg/m³

36 mm - 610 - 630 kg/m³

Glass door storages

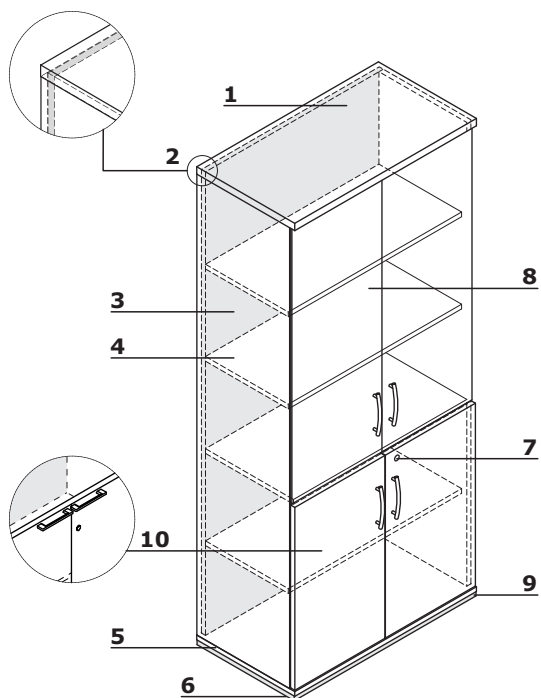

1. Top - MFC 28 mm, ABS edge
2. Back MFC - 18 mm, ABS edges
3. Body - MFC 18 mm, ABS edge
4. Shelf - MFC 18 mm, protection against accidental falling-out, ABS edge
5. Base - MFC 18 mm, ABS edge
6. Leveling feet 27 mm - range 5 mm
7. Patent lock
8. Glass front - basic version AS31 - glass door 3OH, transparent tempered glass 4 mm, universal (left,right);

OPTION WITH EXTRA CHARGE:

- IM300 - Glass door 3OH
- transparent tempered glass 4 mm, with aluminum frame
 - AS300 (AS29+AS30)
 - AS29 - Glass door 3OH
- frosted tempered glass 4 mm, with aluminum frame
- right
 - AS30 - Glass door 3OH
- frosted tempered glass 4 mm, with aluminum frame
- left
 - AS500 - Glass door 5OH
- transparent tempered glass 4 mm, with aluminum frame
9. OPTION WITH EXTRA CHARGE - metal base - colour: M009 - aluminium semi-matt
10. Front - MFC 18 mm, ABS edge, plain hinge 110°
- * Standard - vertical handle, aluminium
 - * Pro (OPTION WITH EXTRA CHARGE) - horizontal handle, aluminium, espagnolette lock - two-point

AS300
(AS29 + AS30)

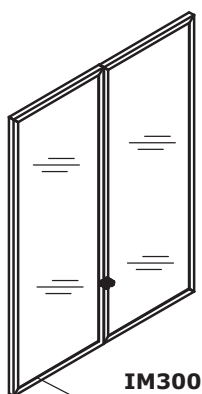

IM300

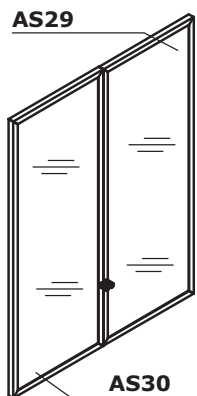

AS30

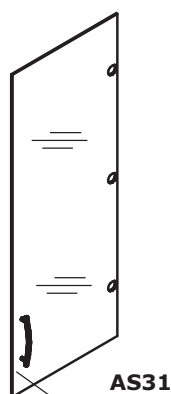

AS31

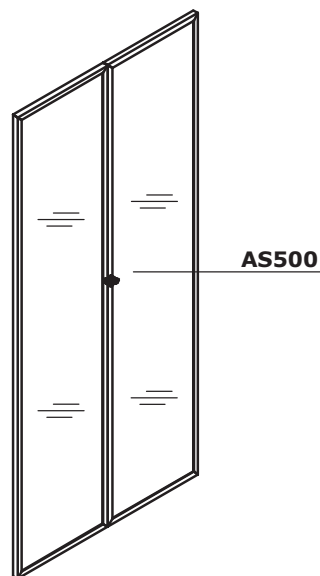

AS500

Glass door storages *



A3902W
402 / 432 / 1129
31.5 kg

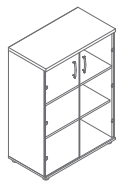

A3504W
801 / 432 / 1129
48 kg

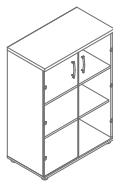

A3504TMW
801 / 432 / 1129
51 kg

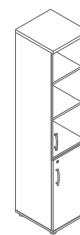

A58P2W**
402 / 432 / 1833
47.5 kg

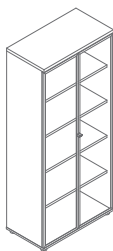

A5504W
801 / 432 / 1833
76.7 kg

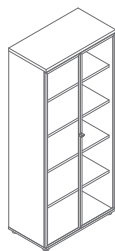

A5504TMW
801 / 432 / 1833
73.7 kg

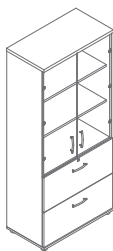

A54D4W
801 / 432 / 1833
76.1 kg

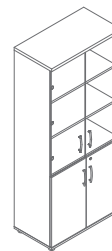









A5404W
801 / 432 / 1833
80 kg

* dimensions expressed in millimeters: width x depth x height
** option - left hand side or right hand side front

Top, base, body, front

			
14 Beech *	26 Aluminum satinato	31 Canadian oak *	34 Chestnut *
			
39 Polar birch *	64 Cocoa *	67 White pastel	106 Lowland walnut *
			
154 Anthracite	08 Black	167 Grey oak *	168 Natural oak *

Front - A54D4W

			
14 Beech	26 Aluminum satinato	31 Canadian oak	34 Chestnut
			
39 Polar birch	64 Cocoa	67 White pastel	106 Lowland walnut
			
154 Anthracite	08 Black	74 Orange high gloss	80 Green high gloss
			
81 Burgundy high gloss	102 Yellow high gloss	108 Blue high gloss	127 Dark pink high gloss
			
148 Grey high gloss	101 Black high gloss	155 Anthracite high gloss	73 White high gloss

* body - II group